

FLT 20

Linear Fresnel Solar Collector

The FLT20 is a concentrating solar collector designed to generate high temperature heat in SMEs industrial thermal processes. FLT20 is supplied in 6m modules (14.5kW) which are connected together to obtain the desire power output.



Pre-assembled solar solution for heat demand in SMEs

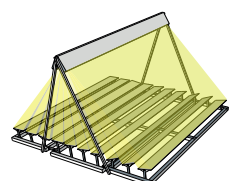
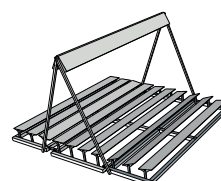
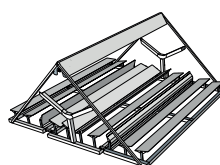
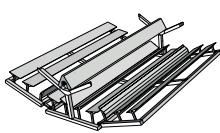
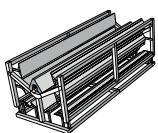

Applications in SMEs

The FLT20 collector uses mirrors which track the sun, and concentrate the sun rays on an evacuated tube, in which the thermal fluid circulates. Once the fluid reaches the design conditions (temperature and pressure), it is supplied into the industry's network.

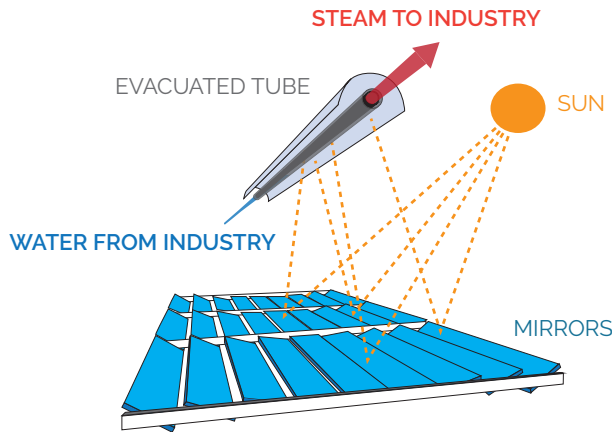

Temperature: From: 80°C To: 300°C
 Pressure: Up to 30 bar
 Fluid: Steam, water and thermal oil

Industry sector	Thermal process
Food & beverages	<ul style="list-style-type: none"> Pasteurization Cooking Drying Cleaning Peeling Frying Boiling
Textile	<ul style="list-style-type: none"> Dyeing Bleaching Washing
Chemical	<ul style="list-style-type: none"> Heat treatment Sterilisation Distillation
Paper	<ul style="list-style-type: none"> Bleaching
Water treatment	<ul style="list-style-type: none"> Sludge Drying
Industrial laundries	<ul style="list-style-type: none"> Calendar ironing Washing

Types of integration

Depending on the type of process, the FLT20 modules can be connected in parallel or in series with the conventional system already in place at the industry.

Solar steam generation (Parallel connection)

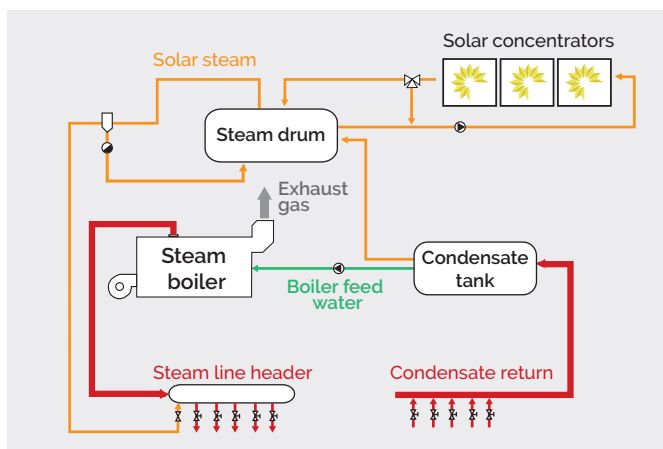

Example: Meat processing factory

The FLT20s are fed with the return of condensates, which generate saturated steam at the same pressure than the conventional boiler. The steam is directly integrated into the customer's network.

Return temperature increase (Series connection)

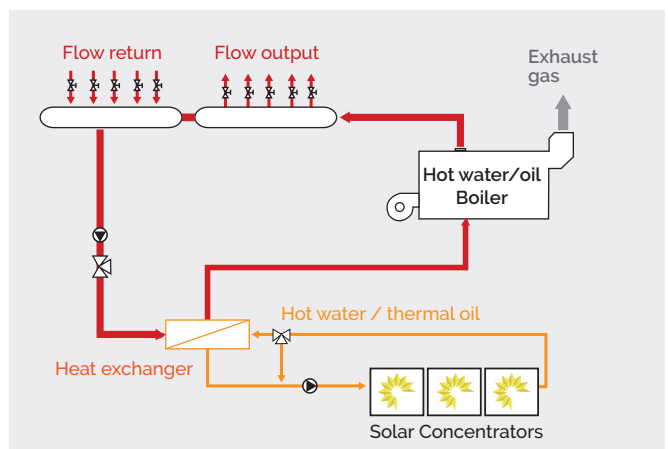

Example: Industrial laundry

The FLT20s are used to increase the temperature of the fluid returning from the process, before it goes back into the boiler.



The solar collector

FLT20 modules are fully pre-assembled in factory, and then transported ready to be used. They are easily deployed and can be easily re-deployed if necessary.



Once in position, the modules are connected together using plug-&-play connections.



Technical data

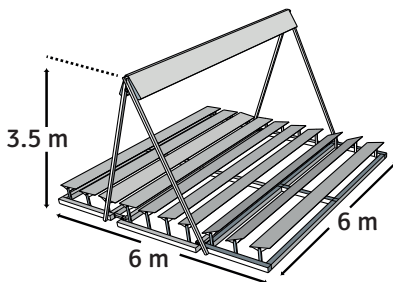

- High reflectivity tempered glass mirrors with individual tracking control
- Secondary reflector
- Vacuum absorber with selective coating
- Remote monitoring

Data for 1 module

Thermal output*	14.5 kWt
Net aperture area	26.4 m ²
Land use	36 m ²
Specific weight (over the collector area)	26 kg/m ²
Max. operational wind speed	70 km/h
Max. wind speed (stowed)	150 km/h
Life expectancy	20 years

*Reference conditions: DNI=900 W/m², T_{inlet}=150°C, T_{outlet}=180°C, T_{amb}=30°C, θ_{trans}=0°, θ_{long}=0°

Optical performance

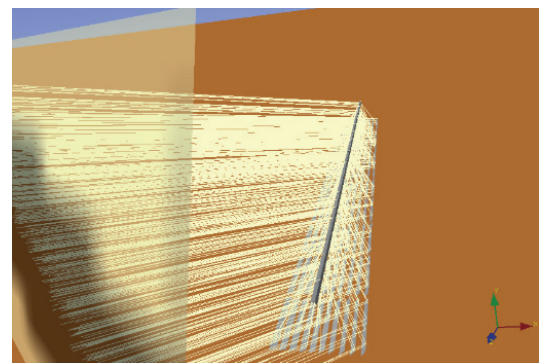
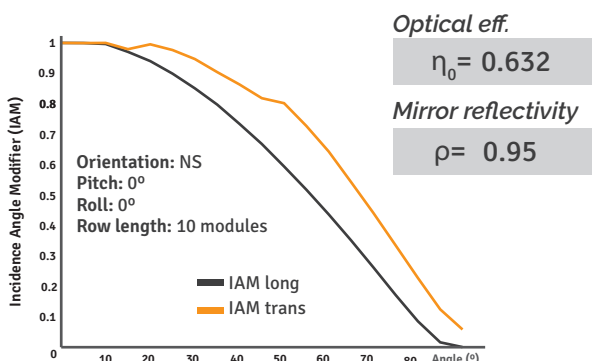

More details regarding the optical performance can be sent upon request at info@solatom.com

Getting started !

Solatom will take care of the overall solar project lifecycle. Initial assessment, project development, transport & integration with the industry, and O&M



Initial assessment with **ReSSSPI** (Free and on-line)

Project
Development

Transport &
Integration

Operation &
Maintenance

ReSSspi allows users without previous solar experience to perform detailed simulations of solar thermal projects.

- 1) Go to www.reSSspi.com and log in
- 2) Create a new simulation
- 3) Introduce the **data** from the industry

Location of the project

Annual demand of thermal energy

Working hours during typical day

Heat transfer fluid used (steam/water/oil)

Temperature inlet & outlet boiler

Outlet pressure of the boiler

Working days during the week

Current price of fossil fuel

ReSPI The
Solar Simulator
for Industrial Processes
www.reSSspi.com

- 4) Use **automatic** or manual simulation (only experts)
- 5) Get energy performance and economic detailed results

References

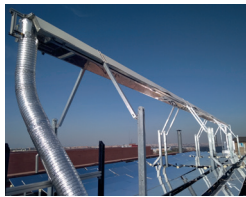

UCIII,
Madrid (Spain)



MARGALIDA,
Girona (Spain)



SOLPINTER,
Almería (Spain)



DADELLOS,
Valencia (Spain)



NATURAL CORK,
Badajoz (Spain)



MAGTEL,
Sevilla (Spain)

■ In operation
■ In construction
■ In development

● Thermal oil
● Pressurized water
● Hot air
● Steam



ITC,
Canarias (Spain)



HERMA,
Caceres (Spain)



SOLPINVAP,
Castellón (Spain)



C/ Pedro Duque, 7, 46022 Valencia,
Spain

Tel: (+34) 691 902 188
info@solatom.com - www.solatom.com